

OmniCure®

UV Bonding • In Control

R2000 Radiometer
UV/VISIBLE RADIOMETER
250 – 1000 nm

USER'S GUIDE

Printed in Canada
035-00310R Rev. 1



LUMEN DYNAMICS

PUTTING YOU IN CONTROL

R2000 Control Panel Software

Minimum Computer Specifications:

300+ MHz processor (Pentium or equivalent)

Windows 98, 2000 or XP

32 Mb RAM

10 Mb for Software Installation

20 Mb for Data Storage

SVGA video 800x600 resolution

One available RS-232 Port

Trademarks

OmniCure® is a trademark of Lumen Dynamics Group Inc. All other product names are trademarks of their respective owners



Table of Contents

1 INTRODUCTION	3
2 CONTROL FUNCTIONS & FEATURES	4
3 FAMILIARIZING YOURSELF WITH THE R2000 RADIOMETER	6
4 USING THE R2000 RADIOMETER	10
4.1 TURNING THE R2000 RADIOMETER ON	10
4.2 CALIBRATION	10
4.3 USING LIGHT GUIDE ADAPTERS.....	11
4.4 USING NON-STANDARD SIZE LIGHT GUIDES	12
4.5 CONNECTING TO A LIGHT SOURCE	13
4.6 MEASURING IRRADIANCE.....	13
4.7 MEASURING POWER.....	13
4.8 MEASURING IN RELATIVE MODE.....	14
4.9 MEASURING IN ABSOLUTE MODE.....	15
4.10 CONNECTING EXTERNAL RADIOMETER DEVICES	15
4.11 STORING DATA	17
4.12 INTERFACING WITH COMPATIBLE OMNICURE UV CURING SYSTEMS.....	18
4.13 CALIBRATING COMPATIBLE OMNICURE UV CURING SYSTEMS.....	18
4.14 USING THE R2000 RADIOMETER WITH A PC.....	19
5 GLOSSARY OF SYMBOLS AND SAFETY PRECAUTIONS	33
6 TROUBLESHOOTING	35
6.1 DISPLAY INDICATES 'ADC' MESSAGE	35
6.2 DISPLAY INDICATES 'BAT' MESSAGE.....	35
6.3 DISPLAY INDICATES 'CAL' MESSAGE.....	36
6.4 DISPLAY INDICATES 'ERR' MESSAGE	36
6.5 DISPLAY INDICATES 'LG' MESSAGE.....	37
6.6 DISPLAY INDICATES 'LGA' MESSAGE.....	38
6.7 DISPLAY INDICATES 'LOC' MESSAGE	38



6.8 DISPLAY INDICATES 'CLO' MESSAGE..... 38

7 TECHNICAL SPECIFICATIONS*..... 39

7.1 OPTICAL 39

7.2 ELECTRICAL..... 40

7.3 MECHANICAL 40

7.4 RS-232 COMMUNICATION COM PORT CONFIGURATION:
40

7.5 ENVIRONMENTAL CONDITIONS..... 41

7.6 REGULATORY COMPLIANCE SAFETY: 41

7.7 WEEE DIRECTIVE (2002/96/EU)..... 43

8 ACCESSORIES..... 46

9 WARRANTY 48



1 Introduction

Congratulations on your purchase of the R2000 Radiometer. This radiometer includes revolutionary technology that elevates the performance and accuracy of hand held radiometers to new heights. It joins the Lumen Dynamics Group Inc. family of spot cure and illumination systems, offering the same high level of innovation, quality and reliability that customers have come to expect from Lumen Dynamics Group Inc.

At the heart of the R2000 Radiometer are two proprietary systems: a non-imaging optical interface that virtually eliminates measurement variation caused by radiance and intensity variations in the light source; and a flat response optical detector system that responds to energy at all wavelengths between 250 and 1000 nm. The result is a hand held, robust and versatile radiometer with accuracy unmatched in the industry.

The R2000 Radiometer provides unique features when combined with the OmniCure 2000 UV Visible Spot Curing System.



2 Control Functions & Features

Features	Benefits
Provides accurate broadband measurements between 250-1000nm	Versatile measurement capability suitable for many different light Sources
Measures power or irradiance	Allows for industry specific measures
Optical interface collects light over a large area	Eliminates beam intensity and radiance dependence
Auto-ranging	Maintains precision over full range
Real-time Mode	Allows for tracking of a varying signal
Relative Mode	References all measurements to a pre-set value
Absolute Mode	References all measurements to NIST traceable units
Fits standard light guides (2mm, 3mm, 5mm, 8mm)	Automatically senses light guide diameters & accommodates industry standard light delivery systems



Features	Benefits
Designed to meet IEC, Canadian and US Standards and CE marking requirements	Ready for use worldwide
Calibration traceable to NIST	Quality assurance
Calibration period of 12 months	Lower cost of operation
Auto turn off	Extends battery life and makes operation easier
RS-232 connection to OmniCure Series of UV Curing Systems	Allows calibration and setup of OmniCure Series of UV Curing Systems
RS-232 connection to PC	Provides PC GUI and electronic calibration of the radiometer
PC GUI	Allows full control of all features and functionality from a PC
Memory	Stores the current reading for future retrieval by PC software

3 Familiarizing yourself with the R2000 Radiometer



The R2000 Radiometer comes complete with:

- 3mm (Red), 5mm (Blue) and 8mm (Green) Light Guide Adapters
- 6' Phono-style cable (RS-232)
- 6' 9-Pin style cable (RS-232)
- CD with GUI software and programming notes
- Carrying case

Light Guide Adapter

Interfaces Lumen Dynamics Group Inc. standard size light guides to the optical input port to promote accurate light delivery into the R2000 Radiometer.

The R2000 Radiometer is able to detect the output dimension of the light guide depending on the colour of the light guide adapter inserted.

Thumbscrew

Used to secure the light guide adapter to the light guide.

Remote Input Connector

A 6-Pin Mini-DIN connector that allows the R2000 Radiometer to interface with optional external cure site and cure ring radiometers.

RS-232 Connector

A 'stereo-phono' style connector that connects the R2000 Radiometer to a PC or compatible OmniCure UV Curing Systems.

LCD Display

The display is a 3.5 digit, 7-segment LCD display.

Front Keypad

The front keypad is comprised of 6 independent membrane-style switches,

ON

Pressing this button will turn the R2000 Radiometer on.

RELATIVE / ABSOLUTE

Each press of this button toggles between relative and absolute mode. The default setting is Absolute mode.

The Relative mode displays measurements as a percentage of a reference value.

OmniCure CAL

Used to calibrate and set up compatible OmniCure UV Curing Systems to a specified irradiance.

POWER / IRRAD

Each press of this button toggles between Power or Irradiance measurements.

EXTERNAL

Enables the R2000 Radiometer to detect and measure external radiometer devices when connected through the remote Input connector.

STORE

This feature is used to save measurement data into a data log memory for future retrieval from a PC.

The data stored is

- Date / Time
- Irradiance and Power
- Serial Number – (OmniCure UV Curing Systems)
- External input channel

Rubber Boot

A protective, flexible cover that allows the radiometer to stand upright on a flat surface. The rubber boot is optional and can be removed when not desired.

When the boot is utilized, the RS-232 connector and Remote Input connector are accessible by lifting flap on the right side of the boot.

Acronyms, Abbreviations and Definitions

<i>PC</i>	<i>Personal Computer</i>
<i>GUI</i>	<i>Graphical User Interface</i>



4 Using the R2000 Radiometer

4.1 Turning the R2000 Radiometer ON

The R2000 Radiometer is fitted with an ON switch located on the front keypad. Press and release the button. All segments on the display illuminate for 1 second.



Note: If a light guide adapter is installed in the optical port, the display will flash the diameter of the light guide adapter for 3 sec.

Note: The R2000 Radiometer will automatically turn OFF after 1 minute if the unit does not detect any optical input, RS232 communication, or keypad activity.

Note: The R2000 Radiometer remains in the same measurement mode that it was in after an occurrence of an automatic power off.

4.2 Calibration

Should the CAL message appear on the display immediately following the R2000 Radiometer being turned ON, it indicates that the unit requires calibration. The message remains illuminated for 5 seconds.



It is recommended that the R2000 Radiometer be calibrated every 12 months to ensure valid

measurements. The calibration is traceable to NIST and a calibration certificate is included at each calibration cycle.

Calibration is authorized only by a certified Lumen Dynamics service center. When calibration is due contact Lumen Dynamics for a return authorization number. Refer to Section 9.0.

4.3 Using Light Guide Adapters

Each R2000 Radiometer includes two standard light guide adapters, 3mm (RED), 5mm (BLUE) and 8mm (GREEN).

One other size is available: 2mm (GOLD)

Note: If the R2000 Radiometer is on when the adapter is installed, the display will flash the diameter of the light guide adapter for 3 sec.

Insert the light guide adapter into the optical input port to the end of its travel. A click should be heard that indicates positive insertion of the light guide adapter.

Insert the light guide into the light guide adapter to the end of its travel. Hand-tighten the thumb screw to secure the light guide into place. Note: The use of a tool to tighten the thumbscrew is not recommended. Over-tightening could cause damage to the light guide.

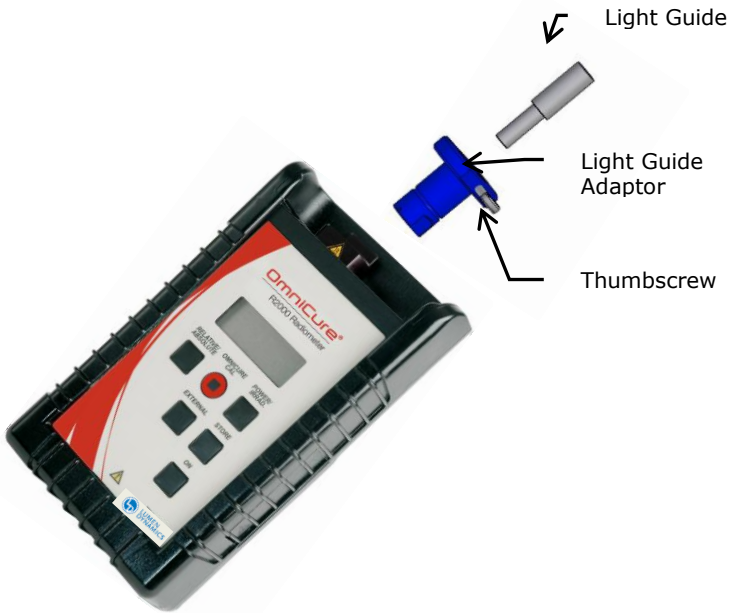

When the light guide adapter is secured it can remain attached to the light guide if the light guide is removed.

To confirm which size light guide is inserted press the ON button simultaneously with the POWER/IRRAD button. The display will show the diameter of the light guide in mm (i.e. 5.0).

4.4 Using Non-Standard Size Light Guides

In order to use non-standard size light guides with the R2000 Radiometer a custom light guide adapter is required. Contact Lumen Dynamics Group Inc. for further details.

Note: The diameter of the light guide must be entered in the PC software before the light guide is used with its custom adapter.

4.5 Connecting to a Light Source

Connect a light guide with corresponding light guide adapter into the optical input port on the R2000 Radiometer. Turn light source ON. Always turn light source OFF before removing light delivery from the R2000 Radiometer. Refer to Section 5 for warnings and safety precautions.

4.6 Measuring Irradiance

When measuring irradiance, the display will show the measurement in either mW/cm^2 or W/cm^2 .



If the display is not showing the " cm^2 ", it indicates that the R2000 Radiometer is in Power mode. Simply press the POWER/IRRAD keypad button to toggle into irradiance mode.

The R2000 Radiometer automatically detects the size of the light guide that is inserted, calculates the irradiance and displays the measurement.

4.7 Measuring Power

When measuring power, the display will show the measurement in either mW or W .



If the display is showing " m^2/cm^2 ", press the POWER/IRRAD keypad to toggle into Power mode.

4.8 Measuring in Relative Mode

The Relative mode displays measurements as a percentage of a reference value. The reference is the power at the point of entering Relative mode.

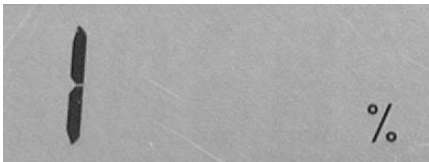

Select either Power or Irradiance mode from the keypad.

Adjust the optical source to the desired reference level, and then press the Relative/Absolute button. The R2000 Radiometer will toggle to Relative mode. All subsequent measurements will be displayed as a percentage of the reference.

A reading of "100%" indicates that the current measurement is the same value as the reference. A reading of "50%" indicates that the current measurement is half of the initial reference measurement. A reading of "200%" indicates that the current measurement is double of the initial reference.

Inserting a light guide from a different source will provide a measurement that is relative to the initial reading as described above.

4.9 Measuring in Absolute Mode

When in Absolute mode, the R2000 Radiometer displays the reading as power or irradiance, depending on which mode is selected.



4.10 Connecting External Radiometer Devices

To use the R2000 Radiometer with optional Cure Site and Cure Ring Radiometers, plug the 6-pin Mini-DIN style cable attached to the external device(s) into the Remote Input connector on the side of the R2000 Radiometer. External radiometer devices are available from Lumen Dynamics Group Inc. as custom ordered items.

Press the EXTERNAL keypad button. The display will show the EXT icon and a number (starting at 1), that corresponds to the external radiometer sensor being detected. This number is shown for a few seconds and then the display shows the corresponding measurement of that device.



If multiple devices are connected each press of the EXTERNAL keypad button will increment to the next external device before returning back to internal mode.

This is indicated on the display when the EXT icon is no longer illuminated.

The measurement mode is dependent on the type of sensor the external device has. For example, the R2000 Radiometer will only measure Irradiance when an external radiometer device is only able to measure Irradiance.

The Power mode becomes disabled and the display will show a 'Loc' message if the user tries to toggle into Power mode.

The same is true for sensors that measure only Power; the Irradiance mode will not be accessible and the display will show a 'Loc' message.

The following illustrates the use of the EXTERNAL feature with four external radiometer devices.

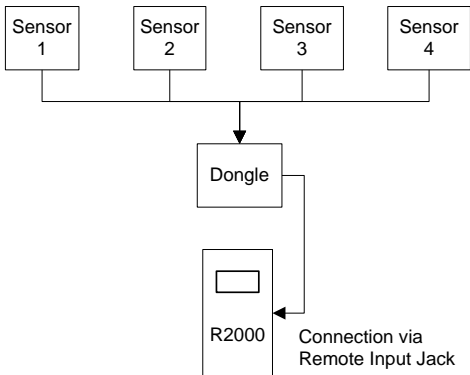

With each press of the EXTERNAL keypad button, the display will show,

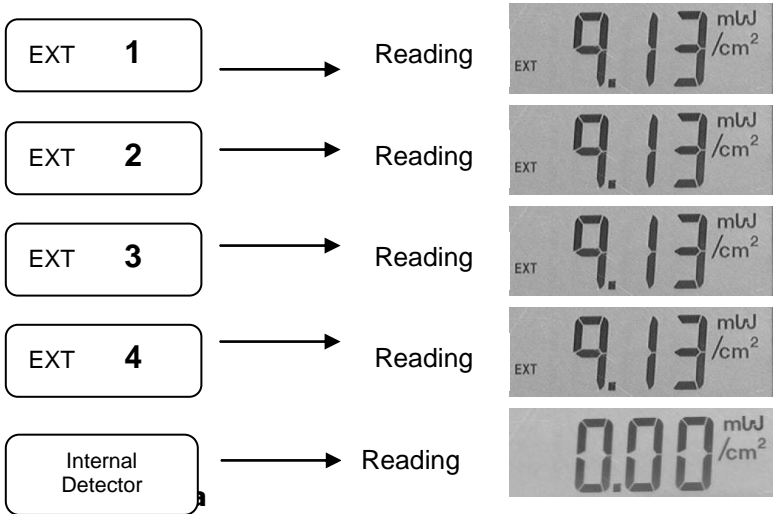

4.11 Storing Data

The R2000 Radiometer is able to store measurements based on what is being detected at the time the STORE button is pressed.

When the STORE button is pressed the display shows the 'MEM' icon and a number (starting at 1), that corresponds to the number of stored readings. The number will increment each time STORE is pressed and the measurement will be stored.

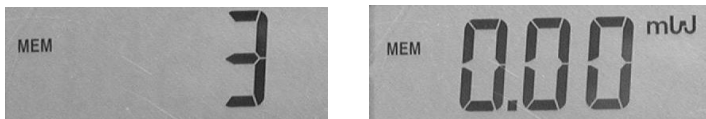

The STORE feature is generally used when the R2000 Radiometer will be connected to a PC via the RS-232 connector. When connected the stored readings are

downloaded into a Data Log as seen on the R2000 Control Panel (via the GUI software provided). The stored readings can only be viewed by downloading to a PC. Once a reading has been stored, it can not be viewed on the R2000 Radiometer display.

4.12 Interfacing with Compatible OmniCure UV Curing Systems

Refer to the OmniCure Curing System User Guide.

The R2000 Radiometer is equipped with one I/O port for communication with compatible OmniCure curing systems. When connected, the R2000 Radiometer is able to calibrate the OmniCure SERIES 2000 UV Curing System and set the irradiance to a specific level.

To interface via the RS-232:

Plug the phono-style cable into the RS-232 connector located on the side of the unit and to the Audio Jack connector located on the front panel side of the OmniCure UV Curing System. The cable supplied is six feet in length.

4.13 Calibrating Compatible OmniCure UV Curing Systems

To initiate a calibration operation, press the OmniCure CAL button. The 'SET' icon will flash and the display will indicate the current set point.



When the keypad is released a series of dashes '----' will illuminate across the display which indicates that the set point is being communicated to the OmniCure UV Curing

system and calibration is being performed. Once the dashes cease to display the calibration cycle is complete.

If the SET 'Err' message appears it indicates that the calibration did not get completed. The calibration must be repeated.



Holding the OmniCure CAL button for 5 seconds will store the current optical input into the radiometer's set point (this feature can be enabled or disabled via PC). The SET icon will cease to flash, while remaining illuminated. The set point can be also be programmed by the PC.

4.14 Using the R2000 Radiometer with a PC

The following are the minimum requirements for a PC to be used with the R2000 Control Panel software:

- 300+ MHz recommended Pentium or equivalent processor
- 32 MB RAM
- 10 MB available storage for software installation
- 20MB additional storage (suggested) for your data files
- SVGA video 800 X 600 resolution, 8-bit color (16-bit color or better recommended)
- Available RS-232 COM port

Operating System Requirements:

Microsoft Windows® 95, 98, NT, 2000, ME or XP

The R2000 Radiometer comes complete with a CD that includes the R2000 Control Panel software that allows

the user to operate and control the Radiometer from a PC.

Installing the R2000 Control Panel Software

- 1) Turn on the PC to be used with the R2000 Radiometer.
- 2) Shut down any other Windows programs currently in use
- 3) Insert the CD supplied with the R2000 Radiometer in the CD-ROM drive of your PC
- 4) Right-click your mouse on the Windows Start button and select Explore
- 5) Left-click on Explore and select the applicable CD drive
- 6) Double click on SETUP.EXE
- 7) Follow the setup instructions as they appear by clicking "next" each time the user prompt appears, until the installation has been completed and "finish" appears. Click on "finish" to complete the installation.
- 8) To access the control panel software program, click on the Windows Start menu and select: programs/ EXFO ►/ R2000 Control Panel. A screen with a title bar displaying "R2000 Control Panel" will appear.

Click on Connect at the top of the screen. The R2000 Control Panel will open when there is a successful connection. This should take no more than a few seconds.



As long as there is a connection between the PC and the Radiometer, data is automatically downloaded to the PC. A 9-pin serial cable is provided with each R2000 Radiometer.

If a problem connecting occurs, a 'No response from radiometer....' Error may be displayed. If this occurs click 'OK' and check the R2000 Radiometer. Press the ON keypad button as necessary and try connecting again.

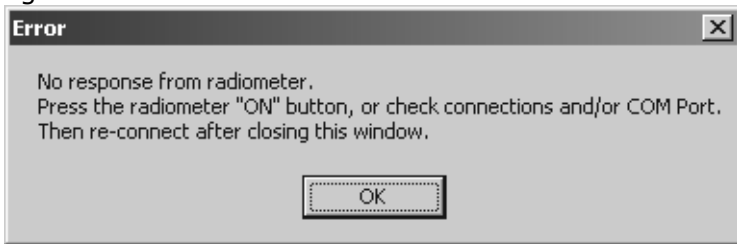

If a problem connecting occurs, the PC may display a 'Failed to open COM port' message. Click 'OK'.



Select from the File pull down menu – COM Ports. Ensure that the applicable COM port is checked and cable is connected to corresponding plug. Try connecting again.

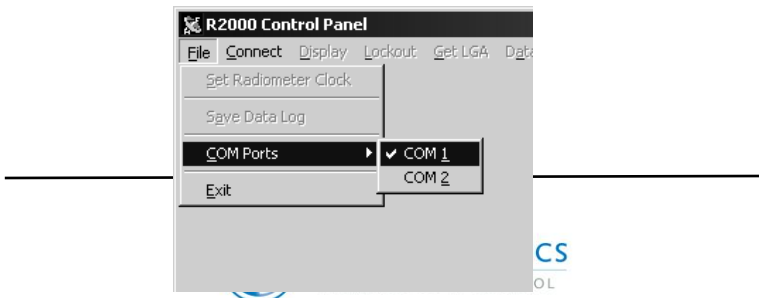

Note: This error may also appear if another program is running that is using the COM port that has been selected.

The following illustrates the R2000 Control Panel:

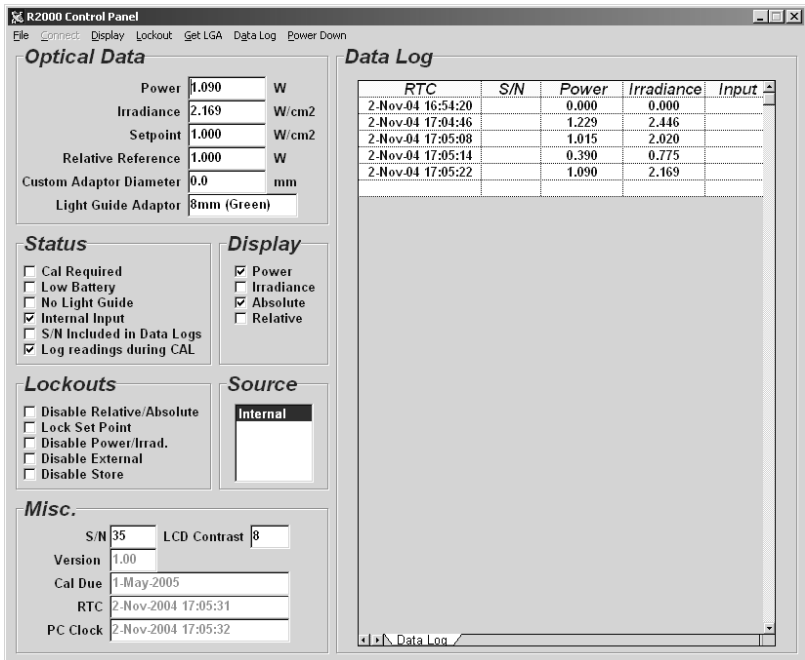

Based on the settings and data being read from the R2000 Radiometer, the information will display in the respective areas of the Control Panel. Some data is user-defined such as:

- Set Point
- Relative Reference

- Custom Adaptor Diameter
- LCD Contrast

Note: When data is entered into a user-defined field the background colour of the field content changes to yellow. To transfer the number into the R2000 Radiometer, press the ENTER key. If successful, the background reverts to the default colour.

If the transfer fails, the background colour reverts to the default colour but the foreground colour becomes red. A dialogue box will appear indicating that the request failed. Click OK to continue.

The **Optical Data** frame displays a combination of real-time data as it pertains to readings being taken from the R2000 Radiometer as well as user-defined fields.

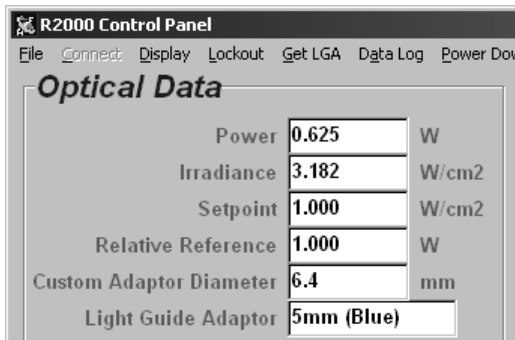

Power – Displays real-time data as it pertains to readings being taken from the R2000 Radiometer. This displays as either mW or W.

Irradiance – Displays real-time data as it pertains to readings being taken from the R2000 Radiometer. This displays as either mW/cm² or W/cm².

Light Guide Adaptor – Displays the diameter and colour of the light guide adaptor being detected by the R2000 Radiometer.

Setpoint – User defined; enter the desired irradiance that will be used to set the compatible OmniCure UV Curing System after the OmniCure CAL button is pressed.

Relative Reference – User defined; enter the desired power reference to be used in Relative mode.

Custom Adapter Diameter – User defined; when using a non-standard light guide with the R2000 Radiometer enter the applicable diameter of the customized light guide adapter. This information must be entered before the light guide is used into the R2000 Radiometer

Light Guide Adaptor – Displays the diameter and colour of the light guide adaptor being detected from the R2000 Radiometer. The **Misc.** frame displays a combination of real-time data as it pertains to readings being taken from the R2000 Radiometer as well as user-defined fields.

The image shows a screenshot of the 'Misc.' menu in the R2000 Radiometer interface. The menu is titled 'Misc.' and contains several fields with their respective values:

S/N	35	LCD Contrast	8
Version	0.85		
Cal Due	13-Apr-2005		
RTC	15-Oct-2004 16:49:41		
PC Clock	15-Oct-2004 16:49:41		

S/N – Displays serial number of the R2000 Radiometer.

LCD Contrast – User defined; indicates level of contrast of LCD Display on R2000 Radiometer; 0 being the darkest and 15 being the lightest.

Version – Displays software version resident on R2000 Radiometer

Cal Due - Displays when next recommended calibration is due.

RTC (Real-Time-Clock) - Displays date and time based on internal clock on R2000 Radiometer.

PC Clock - Displays date and time according to PC clock.



If the RTC date/time stamp is not the same as the PC clock use the Set R2000 Radiometer Clock function under the File menu to synchronize.

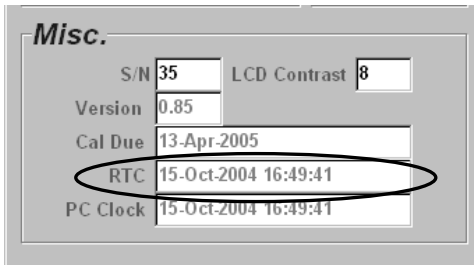
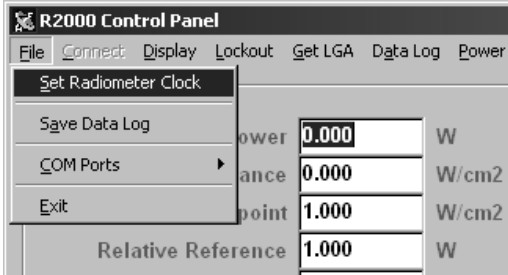

Status

The Status frame indicates the applicable status modes of the R2000 Radiometer.

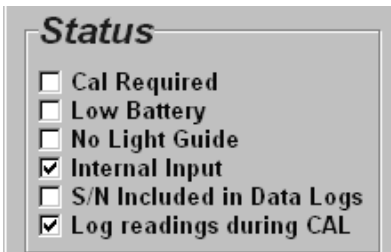

Cal Required – When checked indicates that the R2000 Radiometer is past its recommended calibration date. This is equivalent to the 'CAL' message that appears on the R2000 Radiometer's display.

Low Battery – When checked indicates that the battery is low and should be replaced. This is equivalent to the 'BAT' message that appears on the R2000 Radiometer's display.

No Light Guide – When checked indicates that the R2000 Radiometer is not detecting a light guide. This is equivalent to the 'LG' message that appears on the R2000 Radiometer's display.

Internal Input – This box will be checked when Internal is highlighted in the Source frame. This indicates that optical input is being received from the optical port on the R2000 Radiometer.

S/N Included in Data Logs – When checked indicates that the serial number of the compatible OmniCure UV Curing System will be included in the Data Log.

Log readings during CAL – When checked, indicates that each calibration point during a calibration of a compatible OmniCure UV Curing system will be logged into the Data Log.

Source

The **Source** frame lists the optical inputs being detected by the R2000 Radiometer. Internal indicates detection from the optical input port on the R2000 Radiometer. Other sources such as Ext. #1 and Ext. #2 are sources being detected from external radiometer devices that are connected.

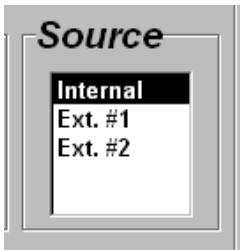

Menu Functions

To operate and control the R2000 Radiometer from the PC, select desired menu functions located across the top of the R2000 Control Panel.

Display

Select the Display menu and then select the desired mode of Power, Irradiance, Absolute or Relative.

Selected options are indicated as checked boxes in the **Display** frame.

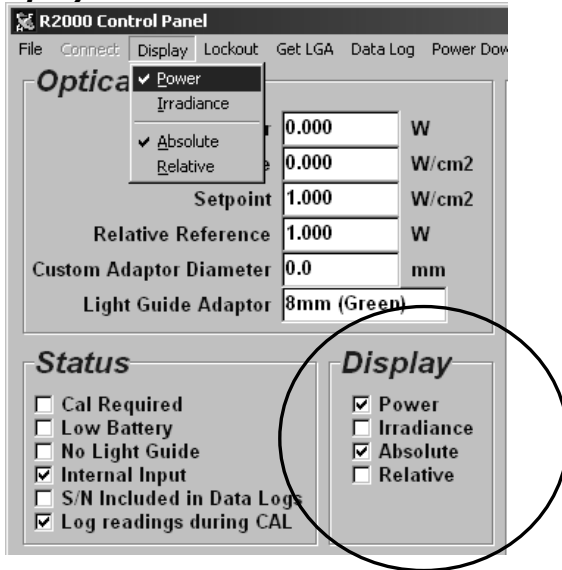

Lockout

Select **Lockout** menu option to disable certain features or functionality from the front keypad of the R2000 Radiometer.

Select from the available list in the pull-down menu. The selections that are checked are indicated in the **Lockout** frame.

If a box is checked, this means that this function will not operate from the front keypad of the R2000 Radiometer.

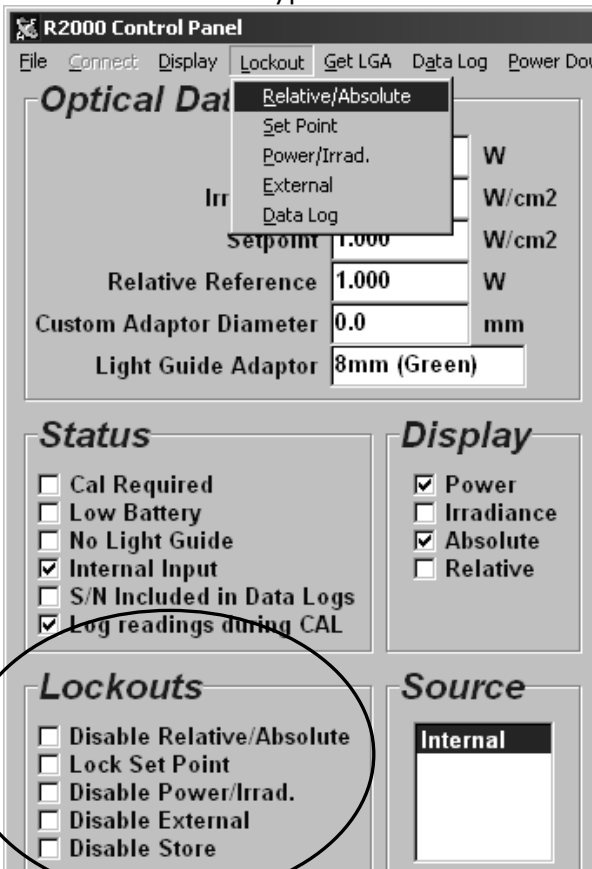

Get LGA

In the event that the size of the light guide adapter must be re-detected remotely, it can be obtained from the Get LGA menu option at the top of the screen. Selecting this will re-detect the colour of the light guide adapter and hence the size of the light guide installed in the R2000 Radiometer.

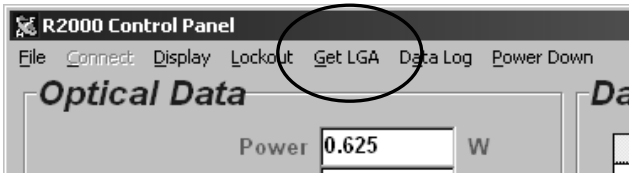

Data Log

Select the Data Log menu option and select the desired option from the pull down list.

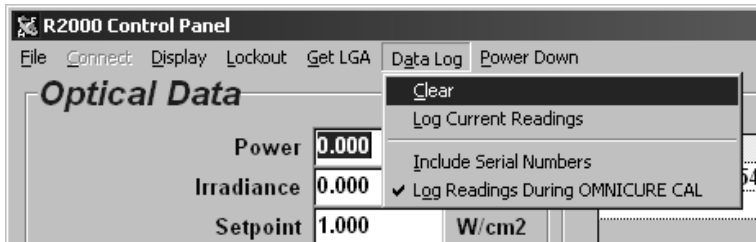

Select Clear to clear any existing data that may be resident in the data log.

Select Log Current Readings to STORE current readings from the R2000 Radiometer. The applicable data will be displayed in the Data Log frame.

Select Include Serial Numbers to obtain the serial number of the compatible OmniCure UV Curing System when the STORE button is pressed.

Select **Log Readings During OMNIGURE CAL** to log each calibration point into the Data Log during a calibration cycle with a compatible OmniCure UV Curing System.

The following is a sample screen shot of the Data Log,

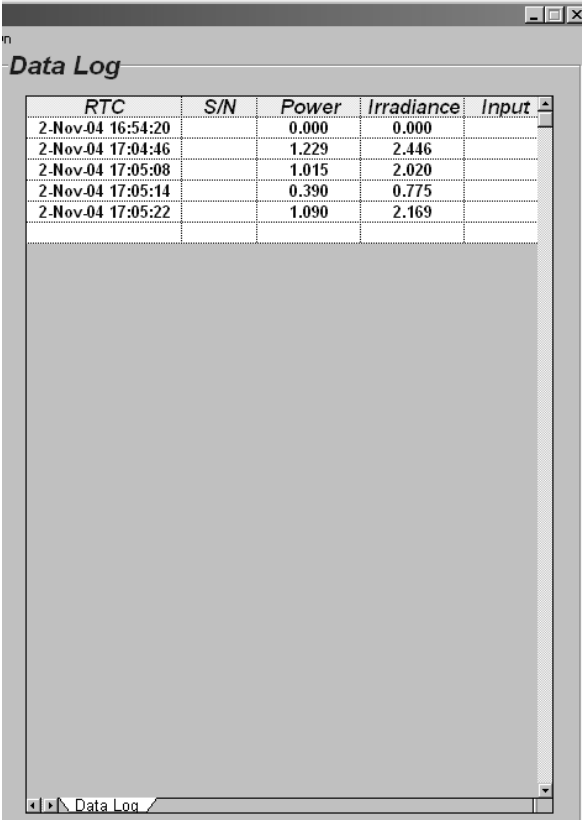

<i>RTC</i>	<i>S/N</i>	<i>Power</i>	<i>Irradiance</i>	<i>Input</i>
2-Nov-04 16:54:20		0.000	0.000	
2-Nov-04 17:04:46		1.229	2.446	
2-Nov-04 17:05:08		1.015	2.020	
2-Nov-04 17:05:14		0.390	0.775	
2-Nov-04 17:05:22		1.090	2.169	

Power Down

Select this menu option to power down the R2000 Radiometer.

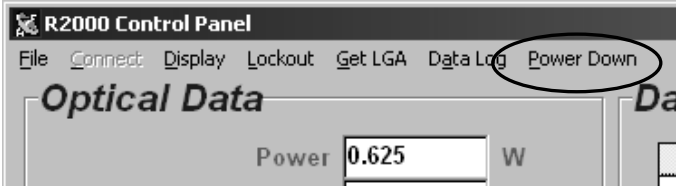

5 Glossary of Symbols and Safety Precautions



CAUTION – RISK OF DANGER

Consult accompanying documents



CAUTION!

Never look into the light emitting end of a light guide. The light could severely damage the cornea and retina of the eye if the light is observed directly. Eye shielding must be used at all times as well as protective clothing to protect exposed skin.



Battery



D.C. Current



Caution, hot surface

SAFETY PRECAUTIONS:



WARNING!

Should the R2000 Radiometer be used in a manner not specified by Lumen Dynamics Group Inc. the protection provided by the equipment may be impaired.



WARNING!

The R2000 Radiometer is supplied with a lithium battery. Lithium batteries present a potential fire, explosion or severe burn hazard. DO NOT attempt to re-charge, disassemble, incinerate, short circuit or expose battery to temperatures above 100 degrees C or expose contents to water!



WARNING!

Used batteries are not to be discarded. Return to the nearest authorized Lumen Dynamics Group Inc. service center for disposal/ re-cycling.

Lithium batteries must have terminals taped with non-conductive material prior to returning for disposal/ re-cycling to prevent short-circuiting. External packaging material must provide adequate protection to contents.

The lithium battery supplied in the R2000 Radiometer DOES NOT contain: mercury, lead, manganese or cadmium. Substitution of any other type of battery is not recommended and may void warranty.



Caution, hot surface

In instances where high power light sources are measured for extended periods of time, the light guide adaptors supplied with the R2000 may become hot! Always use caution when handling these adaptors!

6 Troubleshooting

Error Messages

6.1 Display Indicates 'Adc' Message

If an **Adc** message appear on the display it indicates that there is an internal problem with the unit during power up.

If this occurs, it is recommended that the R2000 Radiometer be serviced. See Section 9.



6.2 Display Indicates 'BAT' Message

If the **BAT** icon appears on the lower left side of the display it indicates that the battery is low and needs to be replaced. Refer to Section 8 for reordering information.



The battery is user replaceable.

Refer to Section 5 for warnings and safety precautions prior to replacing battery.

Remove the rubber boot if it is being used. Using a Philips screwdriver, open the battery compartment located on the back of the unit.

Remove the battery from its holder and replace with the same specified type observing correct polarity (+ and -). Substitution of any other type of battery is not recommended and will void the warranty. Refer to Section 8 for battery reorder information.

Close the battery compartment and hand-tighten into place. Place the R2000 Radiometer back into the rubber boot if desired.

Used batteries are not to be discarded. Return to the nearest authorized Lumen Dynamics Group Inc. service center for disposal/ re-cycling. Use appropriate safety measures found in Section 5.

6.3 Display Indicates 'Cal' Message

If a **Cal** message appears on the display immediately following the R2000 Radiometer being turned ON, it indicates that the unit requires calibration. The message remains illuminated for 5 seconds.

If this occurs, it is recommended that the R2000 Radiometer be returned for calibration. See Section 8.



6.4 Display Indicates 'Err' Message

If an **Err** message appears on the display it indicates that a certain function was not completed successfully.

If the **SET** icon is displayed with the **Err** message it indicates that a SET function was not completed successfully.

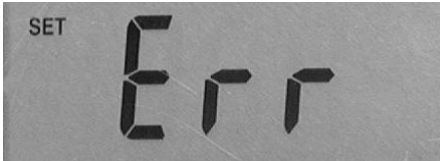

If the **EXT** icon is illuminated on the display with the **Err** message displayed it indicates that the R2000 Radiometer was unable to communicate with an external adapter.

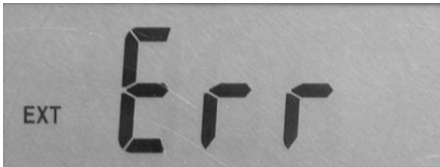

6.5 Display Indicates 'LG' Message

The **LG** message as illustrated below will appear when the R2000 Radiometer is not detecting a light guide.



When a light guide is fully inserted the display will clear. If the message remains after the light guide has been inserted try removing the light guide and re-installing it.

6.6 Display Indicates 'LGA' Message

This message as illustrated below will appear when the R2000 Radiometer is unable to detect the colour of the light guide adapter. If this message appears it is recommended that the light guide adapter be cleaned or replaced.



6.7 Display Indicates 'Loc' Message

If the **Loc** message appears on the display when a keypad button is pressed it indicates that the function has been 'locked out'.



6.8 Display Indicates 'CLO' Message

If the "CLO" message appears on the display it indicates that there is something wrong with the Real-Time Clock (RTC). Most likely that the clock may not be set or has been reset. If this occurs it is recommended that the RTC be reset.

7 Technical Specifications*

7.1 Optical

Wavelength Range: 250-1000 nm

Maximum Range: Power: 1mW – 15W
Irradiance: 2mW/cm² – 475W/cm²

Resolution:

Power Range:	0.007-1.999mW	0.01mW
	2.00-19.99mW	0.01mW
	20-199.9mW	0.1mW
	200-1999mW	1mW
	2.00-19.99W	10mW

Accuracy: ± 5% typical,
± 10% maximum

Auto-ranging:

Power: 1 – 999 mW,
1 – 15W

Irradiance: 2mW/cm² – 999mW/cm²,
1 – 475 W/cm²

* Specifications are subject to change without notice.

7.2 Electrical

Battery Type: 3.6 volt Lithium, non-rechargeable
2.2 Ah

I/O Ports:

RS-232	Pin 1 (Shield)	- GND	} Connect only to equipment that is IEC 950 compliant
	Pin 2 (Ring)	- Tx	
	Pin 3 (Tip)	- Rx	

Remote Input Port: 6-Pin Mini-DIN connector

(use only with optional Cure Site & Cure Ring radiometers)

7.3 Mechanical

Dimensions: 6.5 x 3.9 x 1.7 inches (L x W x H)
Without rubber boot

7.5 x 4.4 x 2 inches (L x W x H)
With rubber boot

Weight: 700 g
With rubber boot

7.4 RS-232 Communication Com Port Configuration:

Baud rate: 19200

Data bits: 8

Parity: None

Stop bits: 1

7.5 Environmental Conditions

Operating Environment Conditions

Installation Category II

Pollution Degree 2

Ambient Temperature: 10 to 35 degrees Celsius

Relative Humidity: 15% to 95% (non-condensing)

Atmospheric Pressure: 700 to 1060 hPa

Altitude: 2000 meters (maximum)

Transport and Storage Conditions

Temperature: -10 to 60 degrees Celsius

Relative Humidity: 10% to 100% (non-condensing)

Atmospheric Pressure: 500 to 1060 hPa

7.6 Regulatory Compliance Safety:

The R2000 Radiometer has been designed to meet the requirements of the following standards:

IEC 61010-1:2001/ EN 61010-1:2001

Safety Requirements for Electrical Equipment for Measurement, Control and Laboratory Use

CAN/ CSA C22.2 No. 61010-1-04

Safety Requirements for Electrical Equipment for Measurement, Control, and Laboratory Use Part 1; General Requirements

UL 61010-1: 2nd Edition

Electrical Equipment for Laboratory Use Part 1: General Requirements

Electromagnetic Compatibility:

EN 61326-1: 2001/ A1/ A2 Electromagnetic
Compatibility Immunity
Testing-Measurement,
Control and Laboratory
Equipment

CE Marking:

Council Directive 73/23/EEC Low Voltage Directive

Council Directive 89/336/EEC EMC Directive

Council Directive 2002/96/EC WEEE Directive



China RoHS

The following table contains substance information for the **Omnicure R2000** as required by China RoHS regulations.

有毒有害物质名称及含量的标识格式

部件名称	有毒有害物质或元素					
	铅 (Pb)	汞 (Hg)	镉 (Cd)	六价 铬 (Cr6+)	多溴 联苯 (PBB)	多溴二 苯醚 (PBDE)
显示器印刷电路板组件	x	○	○	○	○	○
通讯接口印刷电路板组件	x	○	○	○	○	○
电池连接印刷电路板组件	x	○	○	○	○	○

○：表示该有毒有害物质在该部件所有均质材料中的含量均在SJ/T11363-2006标准规定的限量要求以下
 x：表示该有毒有害物质至少在该部件的某一均质材料中的含量超出SJ/T11363-2006标准规定的限量要求
 （企业可在此处，根据实际情况对上表中打“×”的技术原因进行进一步说明）

7.7 WEEE Directive (2002/96/EU)



The symbol above indicates that this product should not be disposed of along with municipal waste, that the product should be collected separately, and that a separate collection system exists for all products that contain this symbol within member states of the European Union.

- The equipment that you bought has required the extraction and use of natural resources for its production. It may contain hazardous substances that could impact health and the environment.
- In order to avoid the dissemination of those substances in our environment and to diminish the pressure on the natural resources, we encourage you to use the appropriate take-back systems. Those systems will reuse or recycle most of the materials of your end life equipment in a sound way.
- The crossed-out wheeled bin symbol indicated above invites you to use those systems.
- If you need more information on the collection, reuse and recycling systems, please contact your local or regional waste administration.



Information to User

FCC Class B Digital Device or Peripheral

NOTE: This equipment has been tested and found to comply with the limits for a Class B digital device, pursuant to Part 15 of the FCC Rules. These limits are designed to provide reasonable protection against harmful interference when the equipment is operated in a residential installation. This equipment generates, uses and can radiate radio frequency energy and, if not installed and used in accordance with the instruction manual, may cause harmful interference to radio communications. However, there is no guarantee that interference will not occur in a particular installation. If this equipment does cause harmful interference to radio or television reception, which can be determined by turning the equipment off and on the user is encouraged to try to correct the interference by one or more of the following measures:

- Reorient or relocate the receiving antenna
- Increase the separation between the equipment and receiver
- Connect the equipment into an outlet on a circuit different from that to which the receiver is connected
- Consult the dealer or an experienced radio/TV technician for help

WARNING

Changes or modifications not expressly approved by Lumen Dynamics Group Inc. could void the user's authority to operate the equipment.



8 Accessories

[Lumen Dynamics Group Inc.](#) carries a full line of replacement parts, supplies and accessories for the R2000 Radiometer.

Our team of light-based technology experts can recommend light delivery solutions for a range of manufacturing, illumination and biomedical applications. We also welcome custom requests for unique light delivery requirements.

3.6V Lithium Battery, Non-rechargeable

Reorder No. 020-00510

Light Guide Adapters

(Thumbscrew supplied)

2 mm - Gold

Reorder No. 019-01043

3mm - Red

Reorder No. 019-01050

5mm - Blue

Reorder No. 019-01051

8 mm - Green

Reorder No. 019-01042

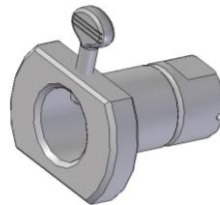

Optional Adapters

Optical accessories provide solutions to a wide range of situations. Optical accessories include the Proximity Measurement Adapter and the optional Lamp Output Adapter.

These adapters expand the range of measurement geometries that can be accommodated.

5mm Proximity Adapter
Reorder No. 019-01041

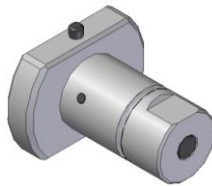

Lamp Output Adapter - Optional
Reorder No. 019-01033

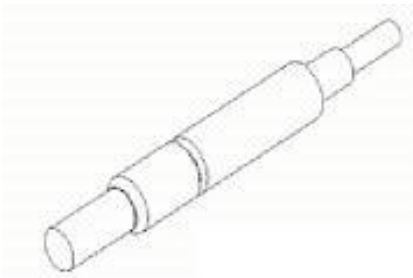

9 Warranty

Lumen Dynamics Group Inc. warrants, to the original purchaser for a period of one (1) full year, calculated from the date of purchase, that the equipment sold is free from defects in material and workmanship.

In the event of a claim under this guarantee, the equipment is to be sent postage and carriage paid, including a description of the fault, to the [Lumen Dynamics Group Inc. Service Centre](#). Returned equipment will not be received without a Return Authorization (RA) Number, issued by the appropriate Service Centre. Alternatively you can fill out a request for Return Authorization (RA#) on our website <http://www.ldgi-omnicure.com/support-need-serviced.php>

Any claims for units received with defects in material or workmanship must be reported to an [authorized Lumen Dynamics Group Inc. Service Centre](#) within 30 days from the original date of receipt. Lumen Dynamics Group Inc. will repair or replace these reported defects free of charge for a period of up to 2 years from the original date of receipt. The equipment must be sent postage and carriage paid.

In order for us to serve you better, include a written description of the fault and the name and telephone number of a contact person who may be contacted for additional service related questions.

Package the R2000 Radiometer in its original shipping case or as appropriate to prevent damage during transport.



In the case of damage caused by wear and tear, careless handling, neglect, by the use of force or in the case of interventions and repairs not carried out by an [Lumen Dynamics Group Inc. Authorized Service Center](#), the guarantee ceases to be valid.

This guarantee may not form the basis for any claims for damages, in particular not for compensation of consequential damages.

Warning

There are no User serviceable parts within the R2000 Radiometer. Opening the main R2000 Radiometer enclosure will void the warranty.

Contact Information

Lumen Dynamics Group Inc.

2260 Argentia Road
Mississauga, Ontario
L5N 6H7 CANADA
Tel.: +1 905 821-2600
Toll.: +1 800 668-8752 (USA and Canada)
Fax: +1 905 821-2055

www.ldgi.com

<http://www.ldgi-omnicure.com/asc.php>

Service or calibration information may be obtained by contacting your nearest OmniCure® Service Center:

Lumen Dynamics	Tel.: +1 905 821-2600
Group Inc.	Toll.: +1 800 668-8752 (USA and
2260 Argentia Rd.	Canada)
Mississauga,	Fax: +1 905 821-2055
Ontario L5N 6H7	http://www.ldgi-omnicure.com/
Canada	http://www.ldgi-omnicure.com/support-need-serviced.php





